

Setup of Robot Programming in MachineLogic for Universal Robots e-Series

Contents

[Overview](#)

[1. Connect your system](#)

[1.1 Physically connecting the UR and MachineMotion controllers using the Robot Safety Module](#)

[1.2 Configuring up the UR controller's Network](#)

[2. Pre-connection Setup on UR controller](#)

[2.1 Installation of the External Control URcap on the UR controller](#)

[2.2 Configuring the External Control URcap](#)

[2.3 Enabling Remote Control](#)

[2.4 Verify Tool Center Point \(TCP\) is Zeroed](#)

[2.5 Create and Run an External Control program](#)

[3. Connecting to the Robot Controller from MachineMotion](#)

[3.1 Configuring a Robot](#)

[3.2 Troubleshooting](#)

Overview

Vention now offers Universal Robot Programming directly in MachineLogic alongside Vention actuators directly in Vention's pendant. With a few extra steps, you can deploy your robot enabled program in minutes.

This document describes the steps necessary to get up and running with **Robot Programming in MachineLogic for Universal Robots e-Series**, which enables the seamless integration of a UR six-axis robot arm alongside Vention motion components, all while staying in Vention's no-code environment. Applications like [range extenders](#), [cobot palletizers](#) and other custom robot cells, are now possible within the Vention platform.

1. Connect your system

In order to program your UR e-Series Robot in MachineLogic, a Vention MachineMotion 2 Pendant V2 ([CE-TP-004-0001_2](#)) and a Vention Robot Safety Module ([CE-SA-009-0000](#)) is **required**, in addition to a MachineMotion v2 ([CE-CL-010-0004](#) or [CE-CL-010-0001](#)) running firmware version **v2.7.0** or later.

1.1 Physically connecting the UR and MachineMotion controllers using the Robot Safety Module

This section discusses connecting a MachineMotion V2 to a Universal Robot controller by way of the Robot Safety Module, in order to program the robot through MachineLogic. The Robot Safety Module acts a 3-port Ethernet switch to enable seamless communication between the MachineMotion, the pendant, and the robot controller (see Figure 1). For more information, refer to the [Robot Safety Module User Manual](#).

The steps below outline the required connections seen in Figure 1 and Figure 2.

1. Connect the Robot Safety Module to the MachineMotion 2 Pendant (CE-TP-004-0001) or any other Vention safety module using the MachineMotion 2 Safety Extension Cable – 5m (CE-CA-102-5001) through the SAFETY IN connector. In case the MachineMotion 2 Pendant or any other Vention safety

- module are used, the included yellow jumper **must be** inserted.
2. Connect the Robot Safety Module to the MachineMotion V2 Controller using MachineMotion 2 Safety Extension Cable – 5m (CE-CA-102-5001) through the SAFETY OUT connector.
 3. Connect the Robot Safety Module to the robot controller using the Robot Safety Module “TO ROBOT” Cable (CE-SA-111-0001) through the TO ROBOT connector. The other ends of the cable, connect as follows:
 - Robot Safety Input Channel 1 Contact 1 (white wire) connects to the first contact of the emergency stop input in the robot controller
 - Robot Safety Input Channel 1 Contact 2 (green wire) connects to the second contact of the emergency stop input in the robot controller
 - Robot Safety Input Channel 2 Contact 1 (pink wire) connects to the third contact of the emergency stop input in the robot controller
 - Robot Safety Input Channel 2 Contact 2 (yellow wire) connects to the fourth contact of the emergency stop input in the robot controller
 - Robot Input Reset Contact 1 (black wire) connects to 24V output in the robot controller
 - Robot Input Reset Contact 2 (grey wire) connects to a configurable input in the robot controller. This input should be configured as “Reset” in the robot’s interface
 - The RJ45 connector connects to the Ethernet port in the robot controller
 4. Connect the Robot Safety Module to the robot controller using the Robot Safety Module “FROM ROBOT” Cable (CE-SA-112-0001) through the FROM ROBOT connector. The other end of the cable, connect as follows:
 - Robot Safety Output 0V Contact 1 (brown wire) connects to a 0V output in the robot controller
 - Robot Safety Output 24V Contact 1 (black wire) connects to a configurable output in the robot controller. This output should be configured as Emergency Stop output in the robot’s interface.
 - Robot Safety Output 0V Contact 2 (blue wire) connects to another 0V output in the robot controller
 - Robot Safety Output 24V Contact 2 (white wire) connects to a configurable output in the robot controller. This output should be configured as Emergency Stop output in the robot’s interface.
 5. (Optional) Connect the Reduced Mode inputs in order to enable the use of Free Drive on the Vention Pendant V3. Enabling Free Drive on the Vention Teach Pendant V3 requires enabling Reduced Mode. Follow these steps in order to enable Reduced Mode automatically when Free Drive is activated. Note that this is not considered a safety-rated use of Reduced Mode.
 - Digital Out pin 0 connects to Configurable Input 6 and Configurable Input 7.

NOTE: If your system has more than one controller set up in a [Multi-Controller configuration](#), the safety chain which includes the Robot Safety Module and the Pendant must be connected to the **parent** controller.

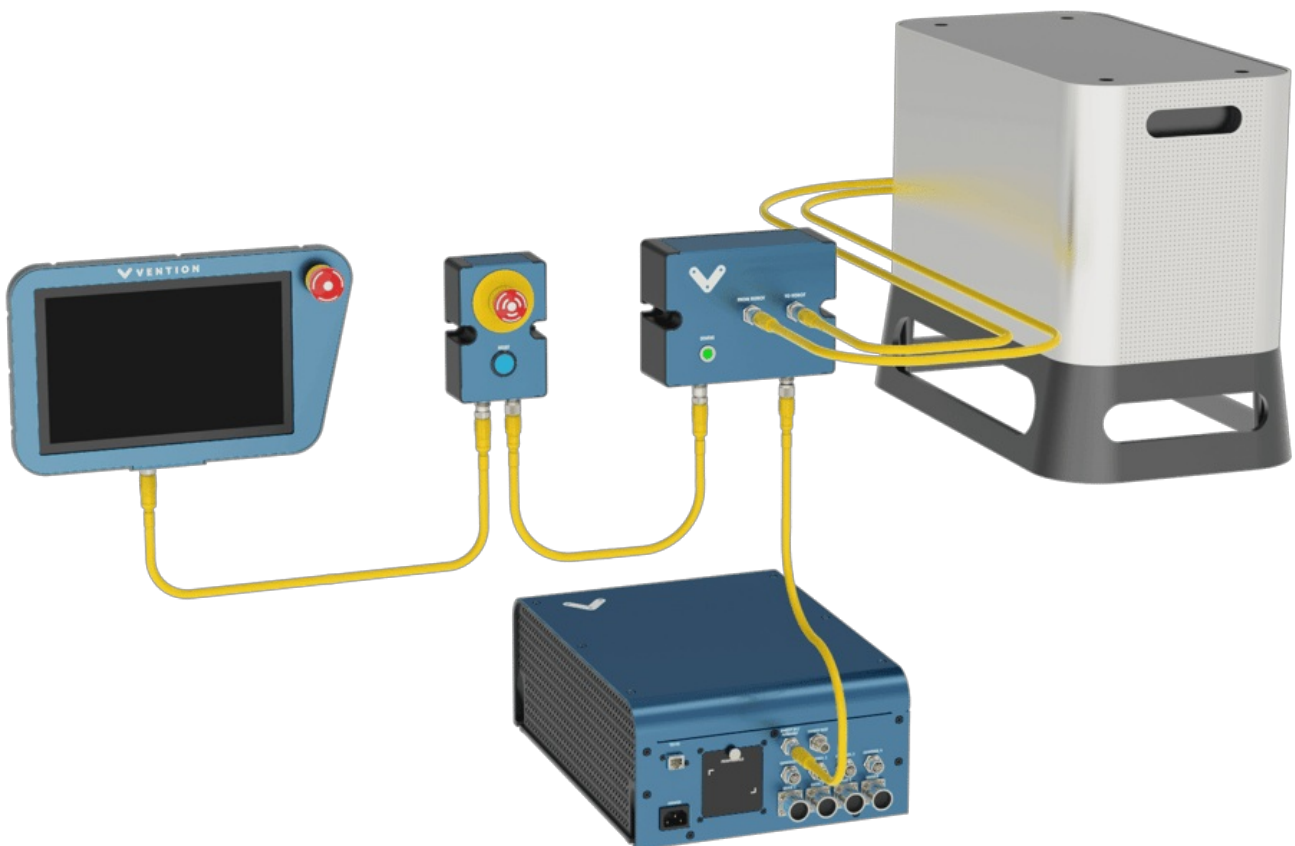

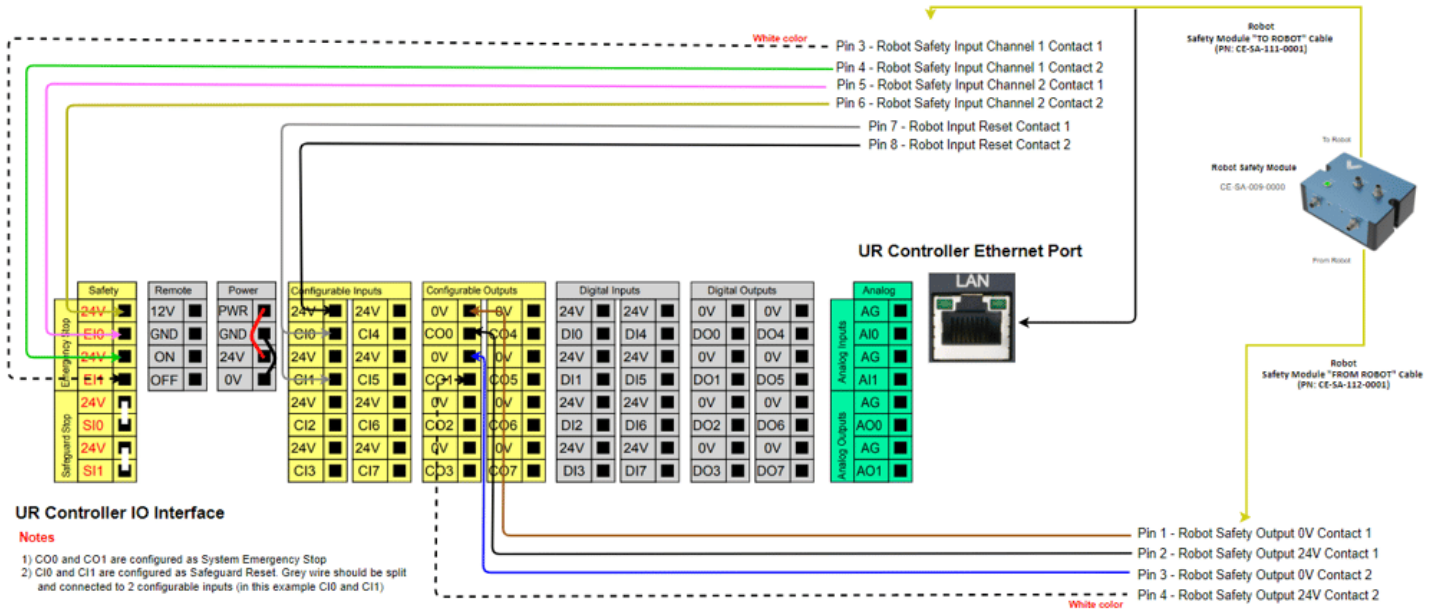

Figure 2: Wiring diagram for Robot Safety Module with Universal Robots Controller

1.2 Configuring up the UR controller's Network

On the UR teach pendant home screen, select **Menu > Settings > System > Network**. Select **Static Address** as your network method & change the **IP address** to **192.168.5.3**, **Subnet mask** to **255.255.255.0**, and **Default Gateway** to **0.0.0.0** (see Figure 3a & 3b). Select **Apply** when done.

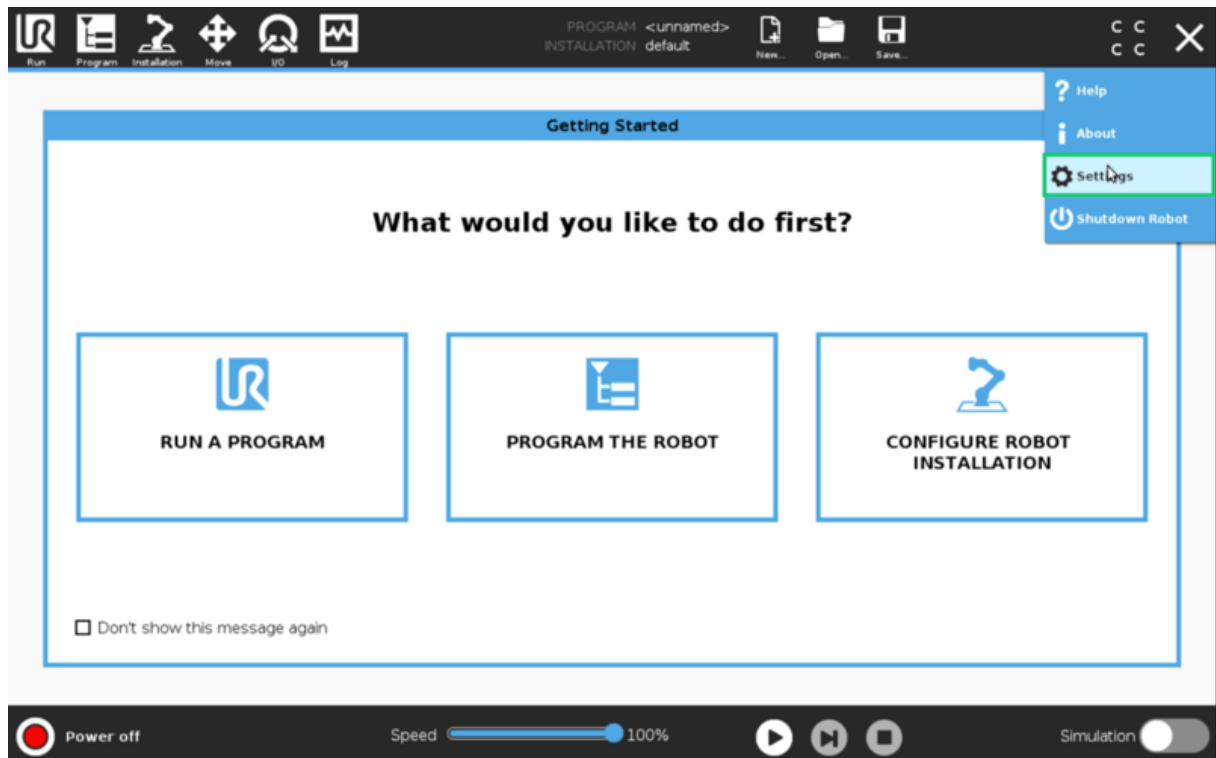

Figure 3a: Opening the settings screen

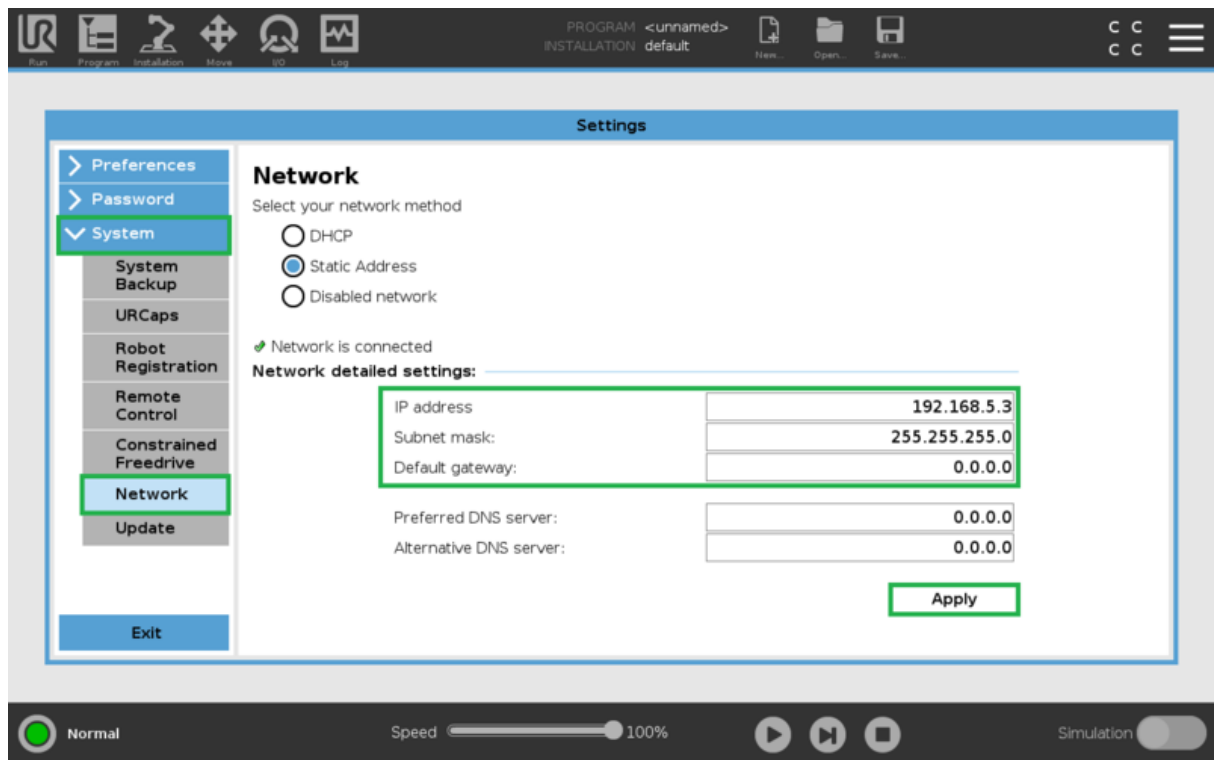

Figure 3b: Robot configuration with Robot Safety Module

2. Pre-connection Setup on UR controller

2.1 Installation of the External Control URCap on the UR controller

Step 1: Insert the USB drive

Vention's *Robot Programming in MachineLogic for Universal Robots e-Series* software is distributed on a USB flash drive and must be installed on the UR teach pendant before continuing onto working in the Vention pendant. To install the URCap, insert the USB drive into the UR teach pendant's USB port.

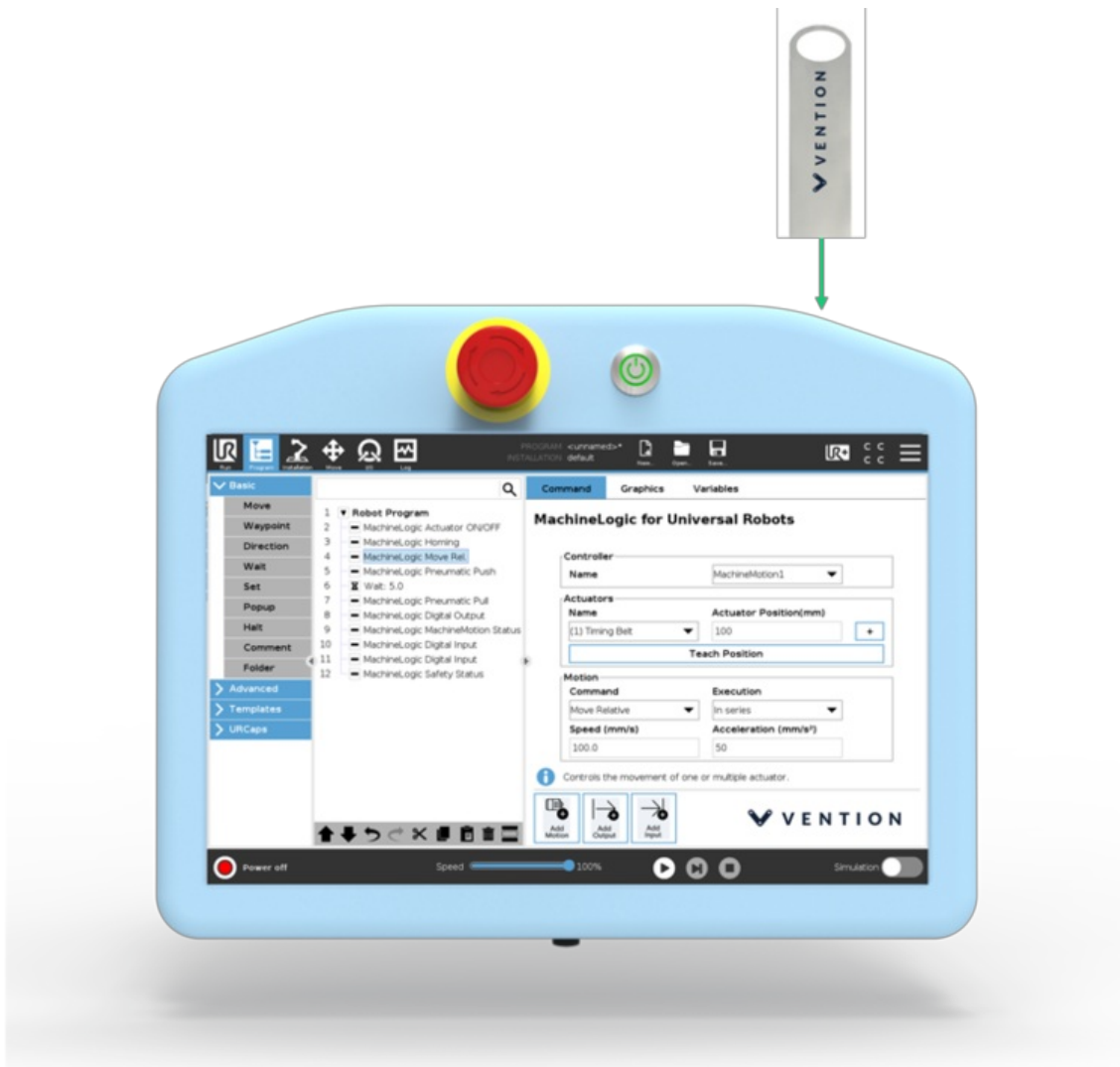

Figure 4: Location of the UR teach pendant's USB port

Step 2: Add the External Control URCap to the UR environment

On the teach pendant home screen, select **Menu > Settings** (see Figure 4a).

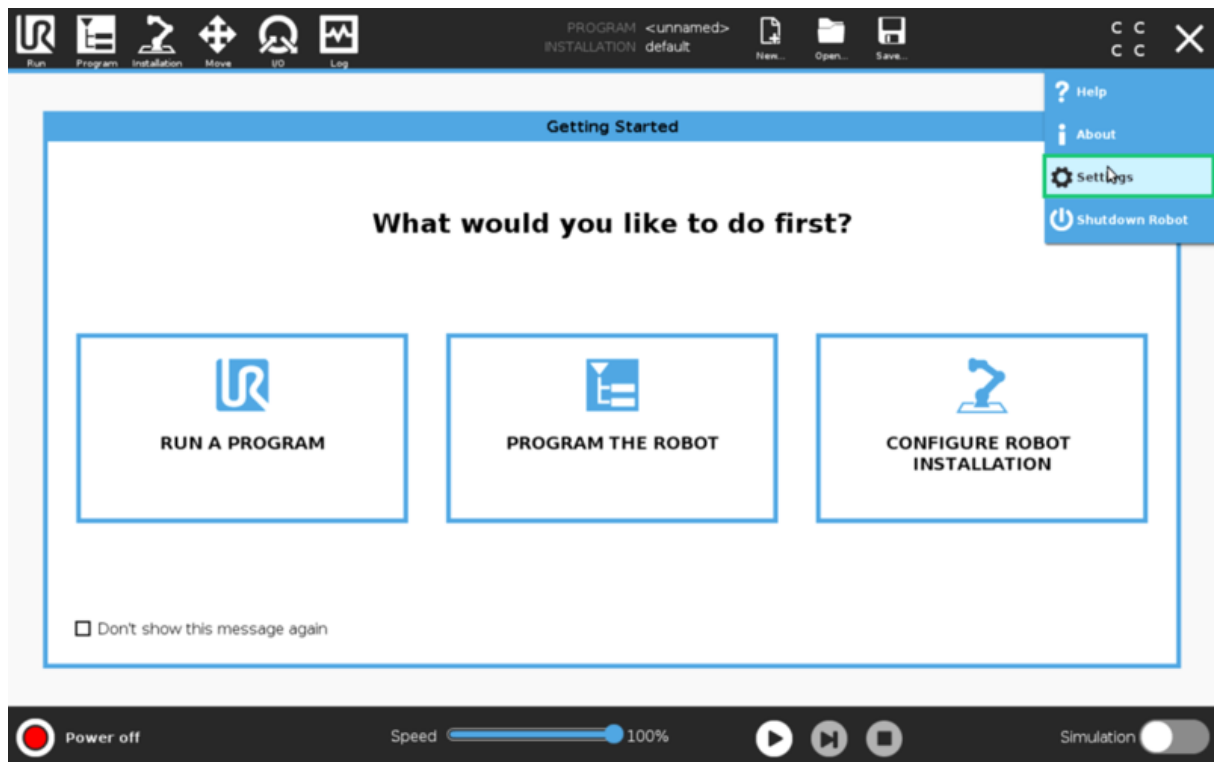

Figure 4a: Opening the settings screen

Select **System** > **URCaps**, then click the + icon at the bottom of the screen to add a new URCap to the UR teach pendant (see Figure 4b).

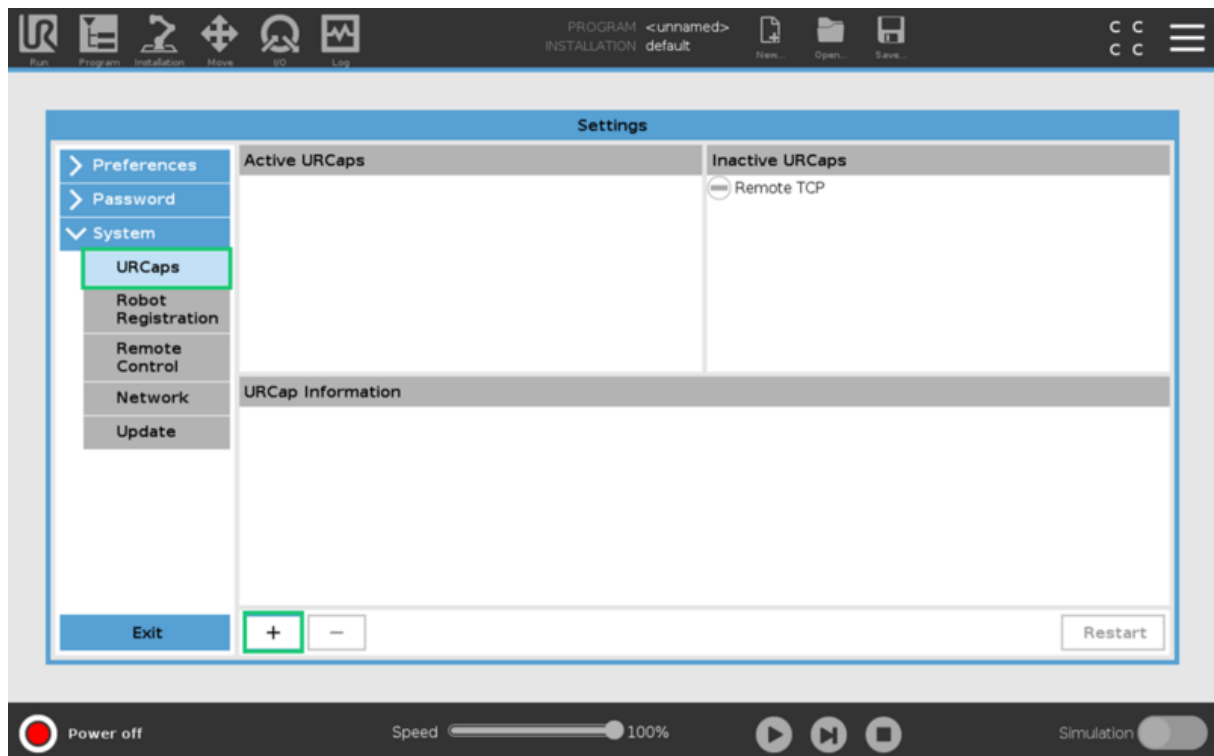

Figure 4b: Opening the URCaps installation screen

Select the **.urcap** file and click **Open** to install the URCap extension (see Figure 4c).

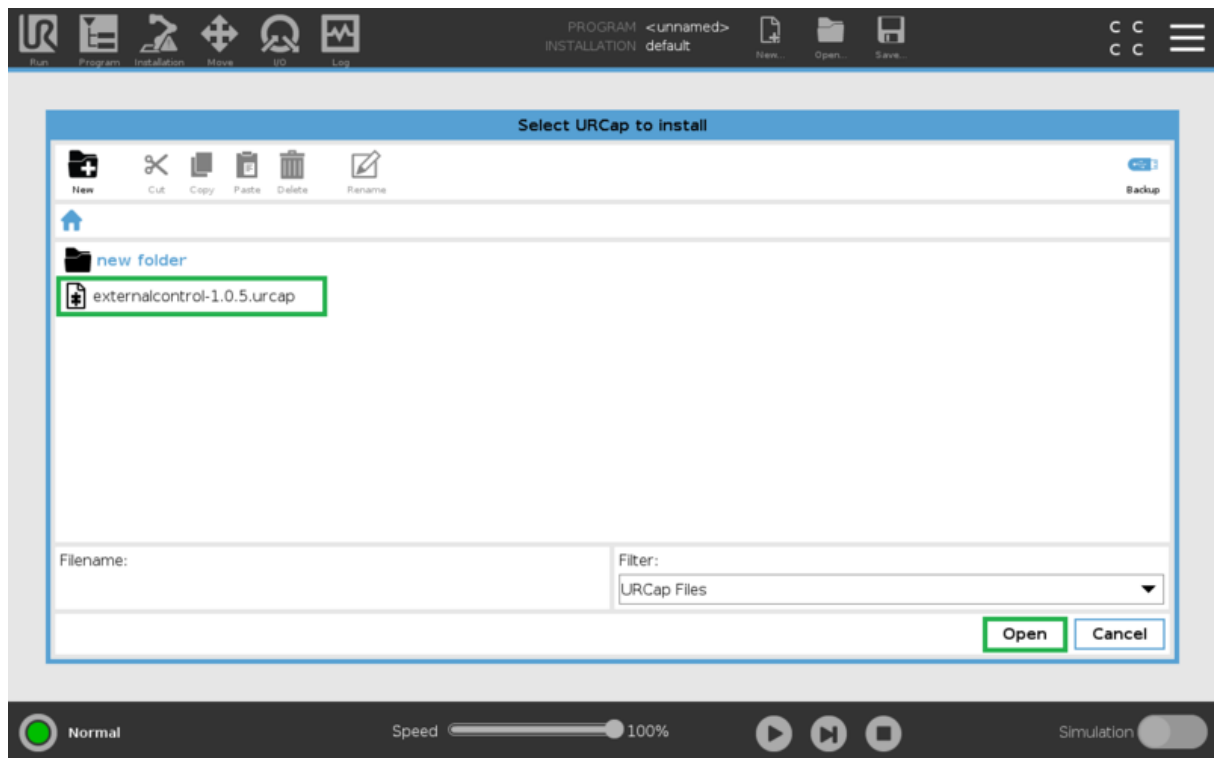

Figure 4c: Adding the URCap file

Step 3: Restart the UR controller

When prompted to do so, restart the UR controller to complete the installation (see Figure 5).

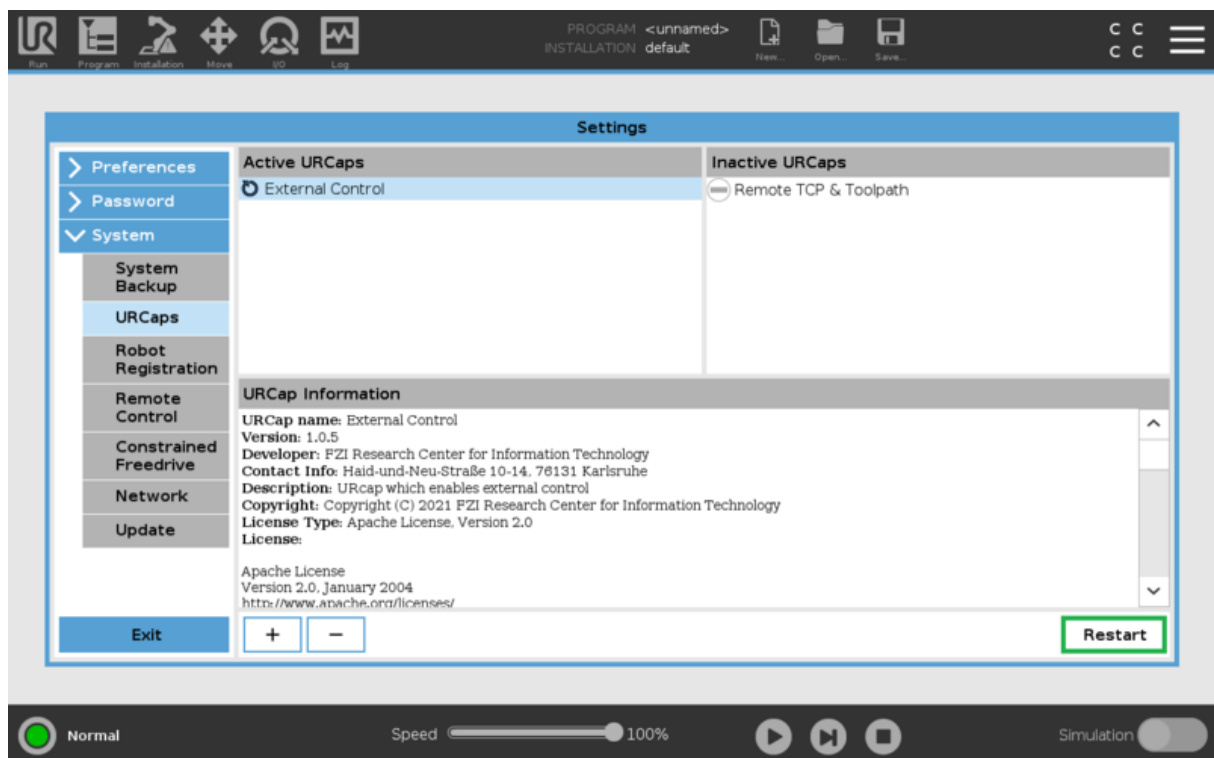

Figure 5: Restarting the system

2.2 Configuring the External Control URCap

Step 1: Navigate to URcaps Installation Page

On the teach pendant, select **Installation** > **URcaps** (see Figure 6).

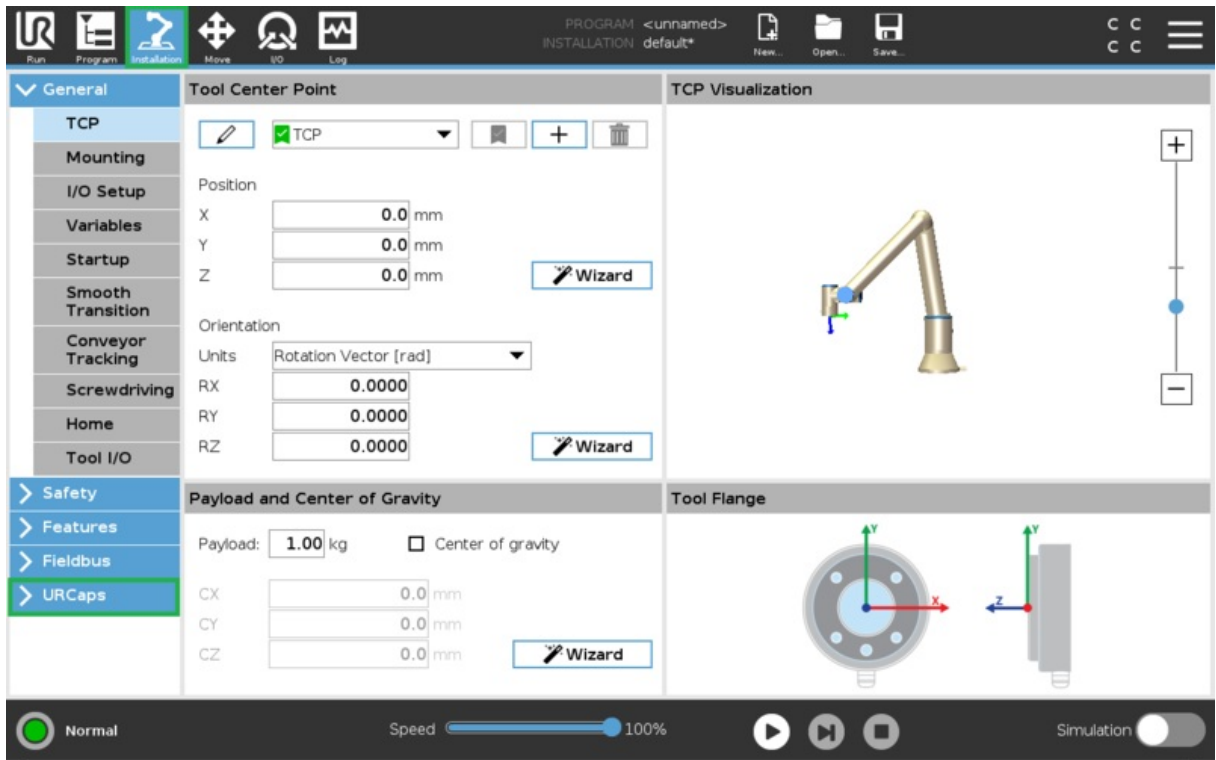

Figure 6: Opening the URCaps settings screen

Step 2: Set Host IP and Custom Port

Change the **Host IP** to **192.168.5.1** and the **Custom Port** to **50002** (see Figure 7). You may use any **Host name** desirable.

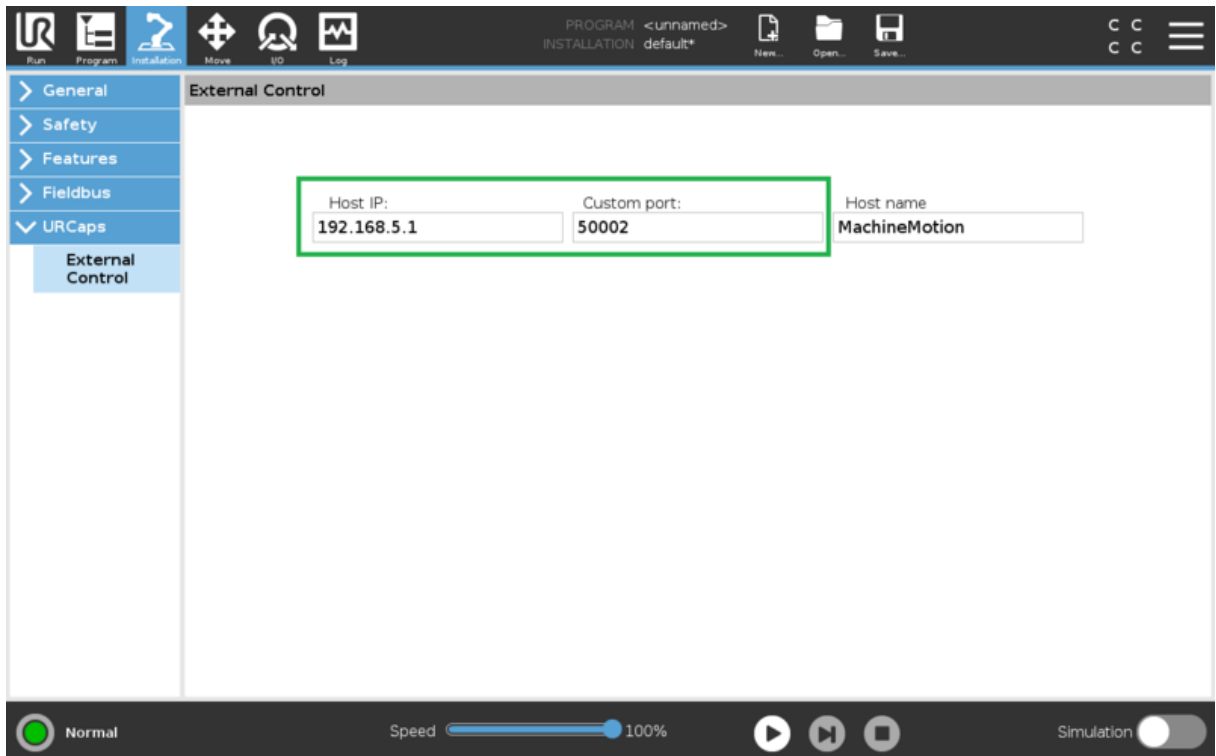

Figure 7: Setting URCap Host IP and Custom Port

2.3 Enabling Remote Control

On the teach pendant home screen, select **Menu > Settings** (see Figure 8a).

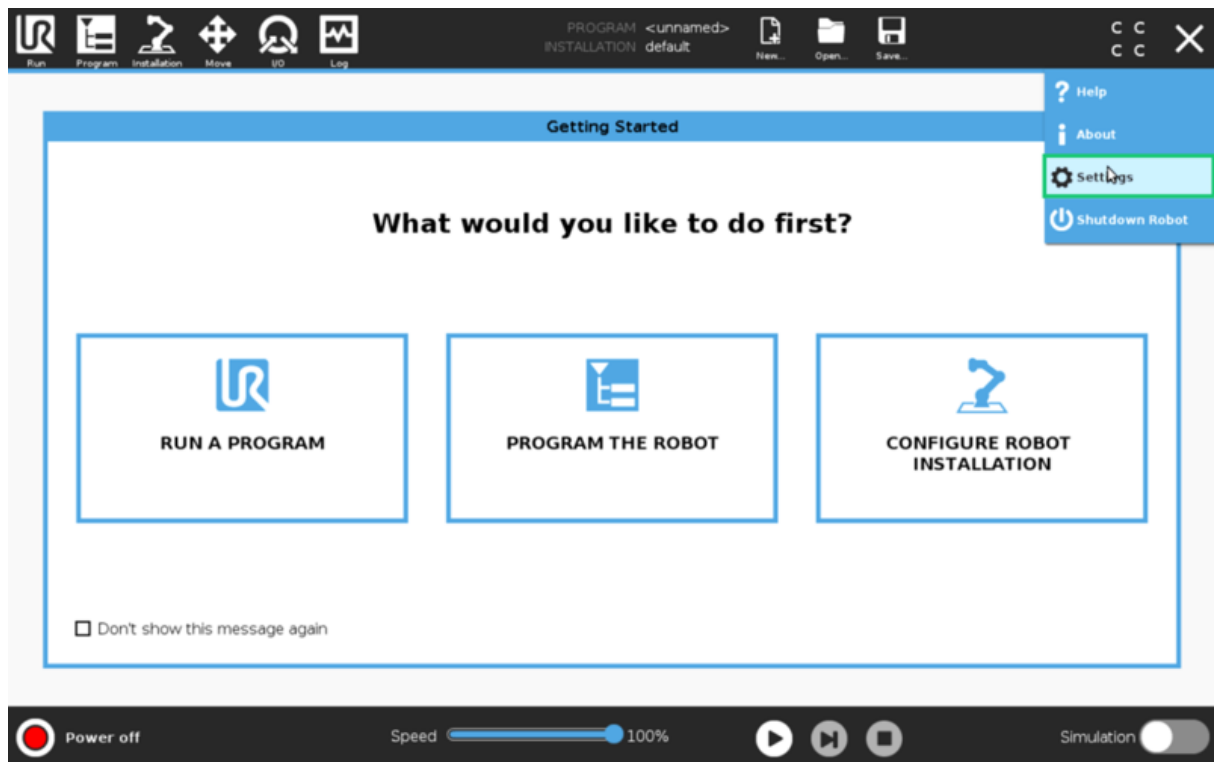

Figure 8a: Opening the settings screen

Select **System > Remote Control**, then click the **Enable** (see Figure 8b).

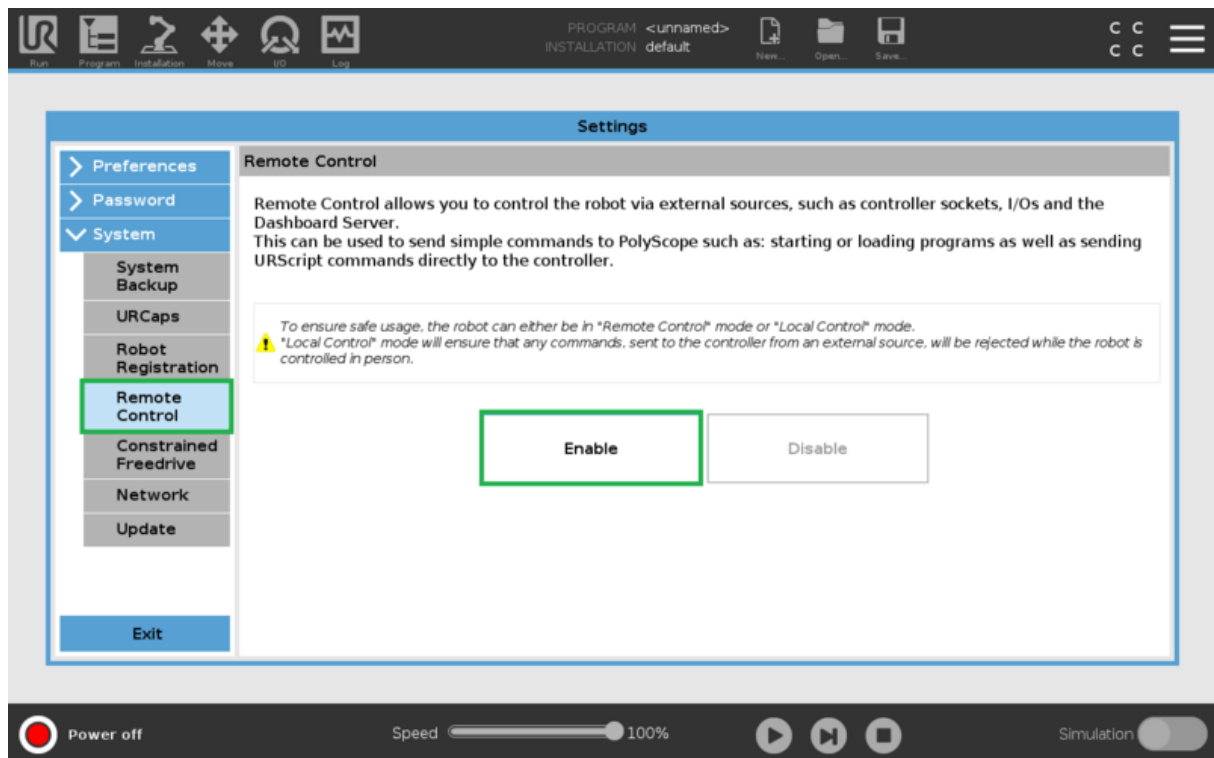

Figure 8b: Enable Remote Control

2.4 Verify Tool Center Point (TCP) is Zeroed

The Tool Center Point, or TCP, defines the coordinate system found at the end of the tool mounted to the robot. For **Robot Programming in MachineLogic**, the TCP, whether an end-of-arm tool is mounted or not, is located directly at the robot's flange, also known as position 0, 0, 0.

On the teach pendant, select **Installation > General > TCP**, and verify that all values associated to **X**, **Y**, and **Z**, as well as **RX**, **RY**, and **RZ**, are set to zero (0) (see

Figure 9). If not, make the necessary changes.

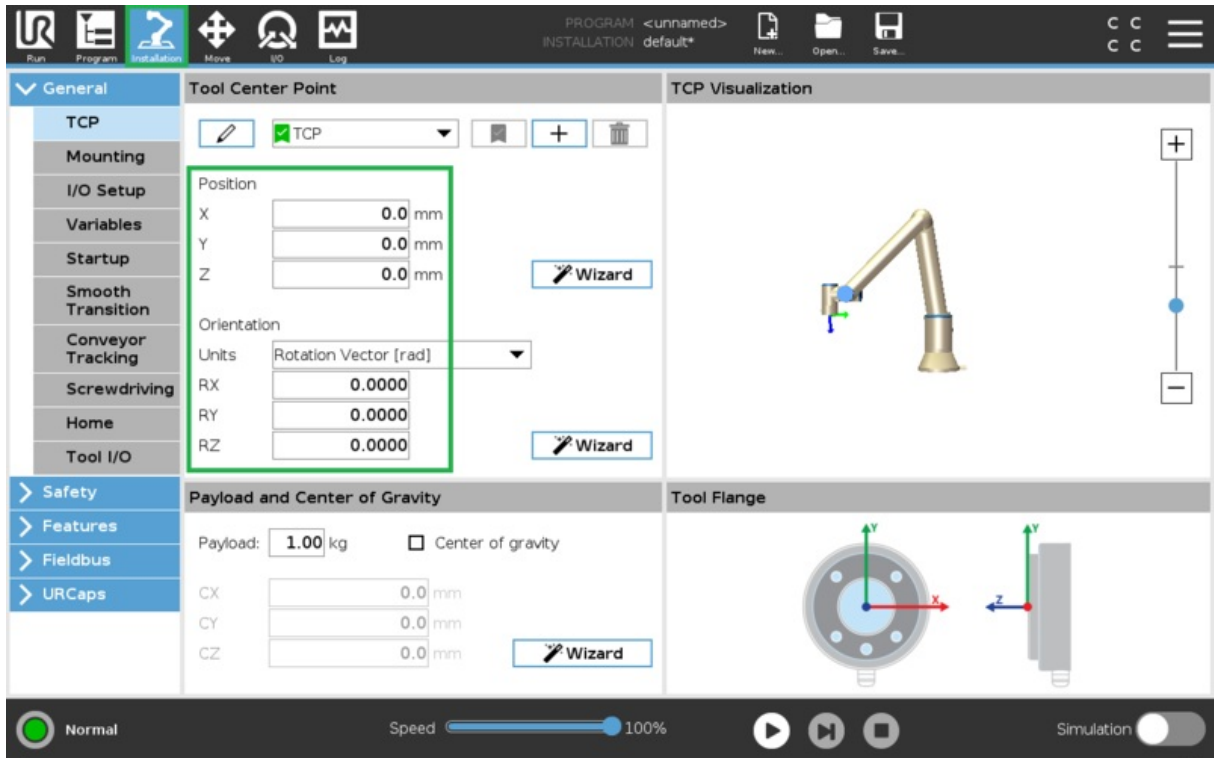

Figure 9: Opening the URCaps settings screen

2.5 Create and Run an External Control program

Step 1: Create a new program

On the navigation bar of the teach pendant, select **New... > Programs** (see Figure 10).

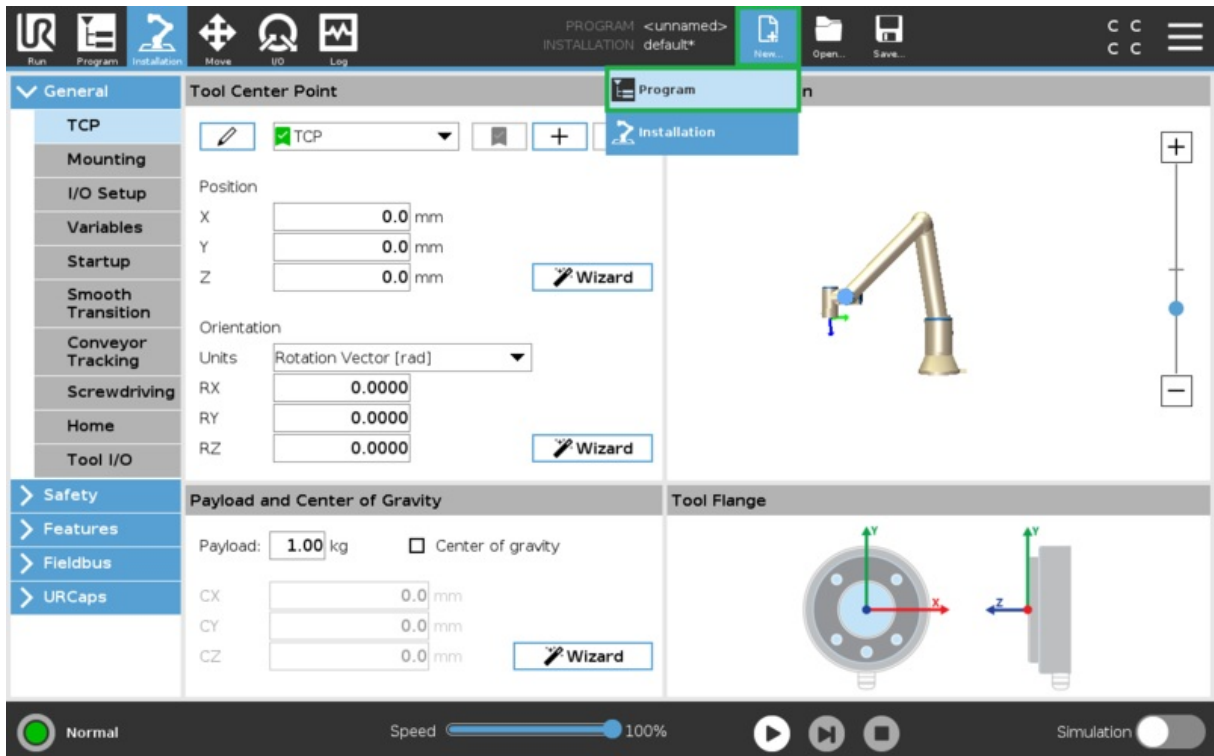

Figure 10: Creating a new program

Step 2: Add the External URCap to the program

On the left-hand side navigation tree, select **URCaps** > **External Control** (see Figure 11). You should see **Control by Host name**** appear under the program tree view. Verify that the information found on the right-hand side (**Host IP** and **Custom port**) match what was set in section 2.2 - Step 2. The program can be saved for future use by selecting **Save... > Save Program As...**

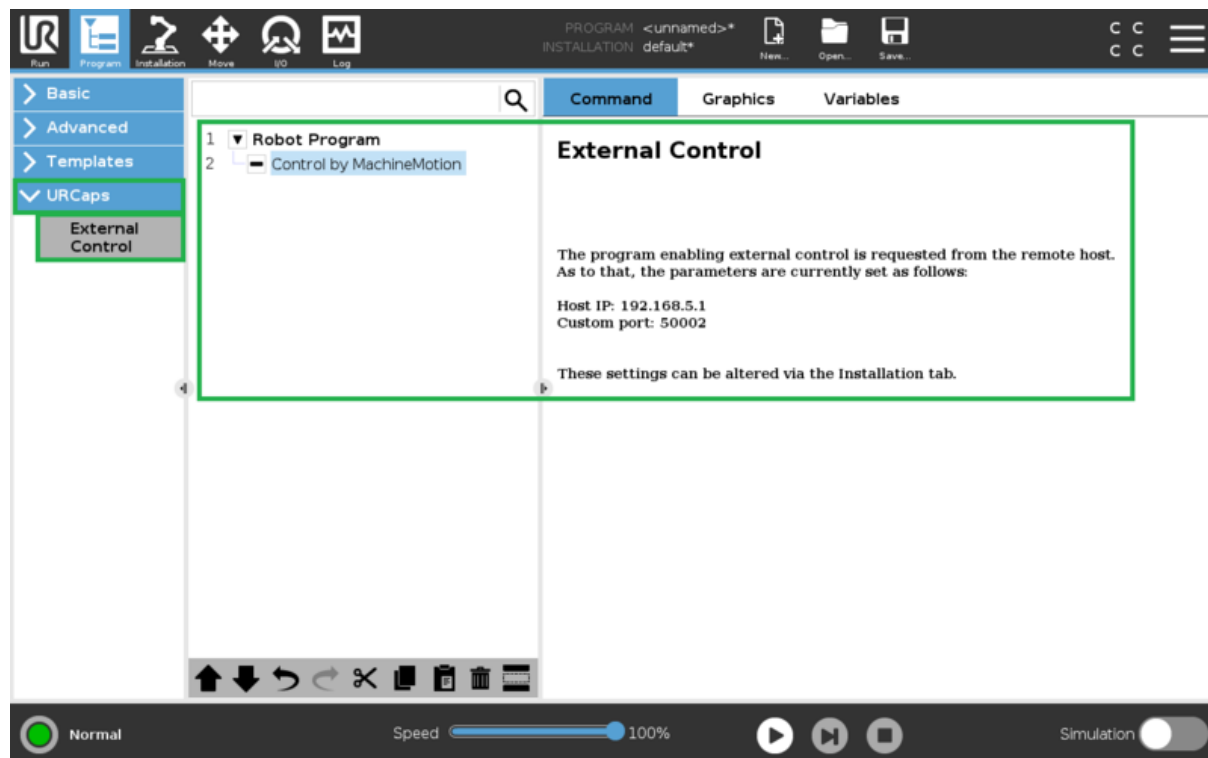

Figure 11: Adding External Control to program

Step 3: Change from Local to Remote Control

NOTE: This step is important and often forgotten. The robot controller must be in Remote Control mode for MachineLogic to properly connect.

At the right of the navigation bar of the teach pendant, select **Local** > **Remote Control** (see Figure 12).

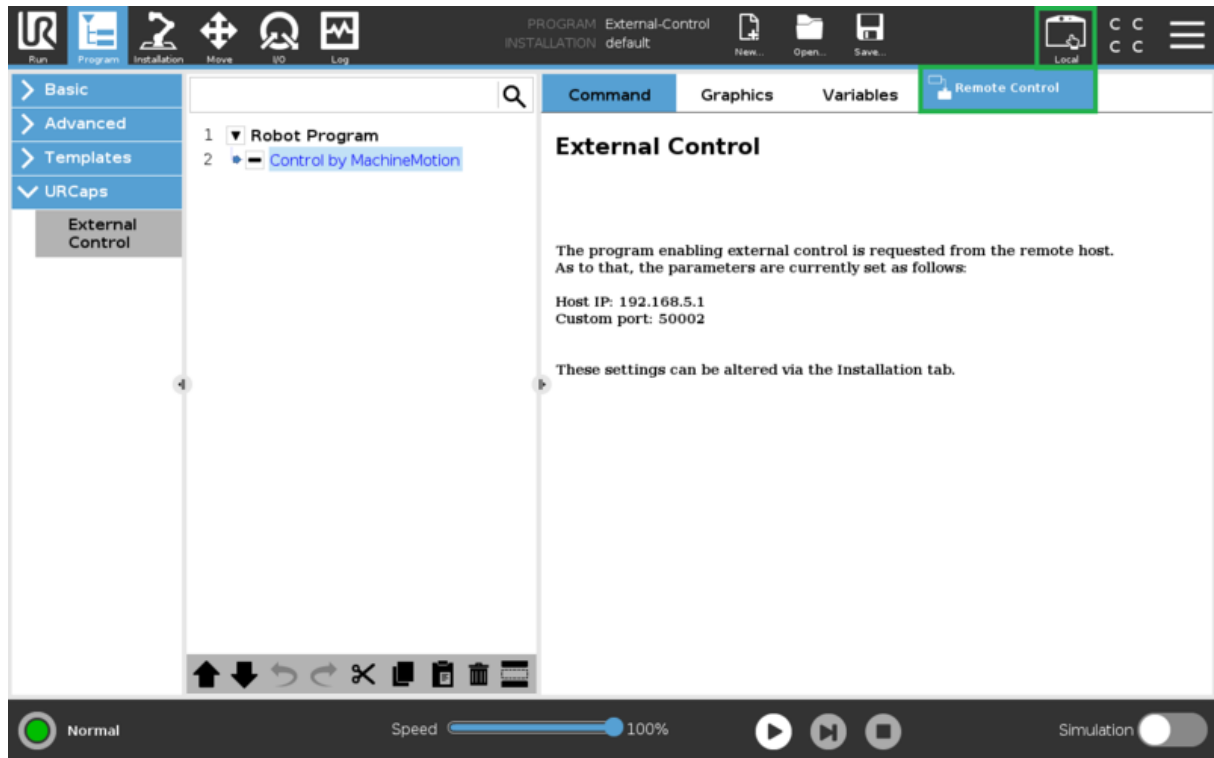

Figure 12: Turn on Remote Control

3. Connecting to the Robot Controller from MachineMotion

With the Universal Robot controller now configured to be externally controlled, Vention's MachineMotion v2 controller can now configure the robot directly in the Control Center, similarly to any other Vention actuator.

3.1 Configuring a Robot

Step 1: Navigating to the Configuration page

On the Control Center main menu, select **Machine Configuration** (see Figure 13). You may also select **Configuration** if not on the main menu page.

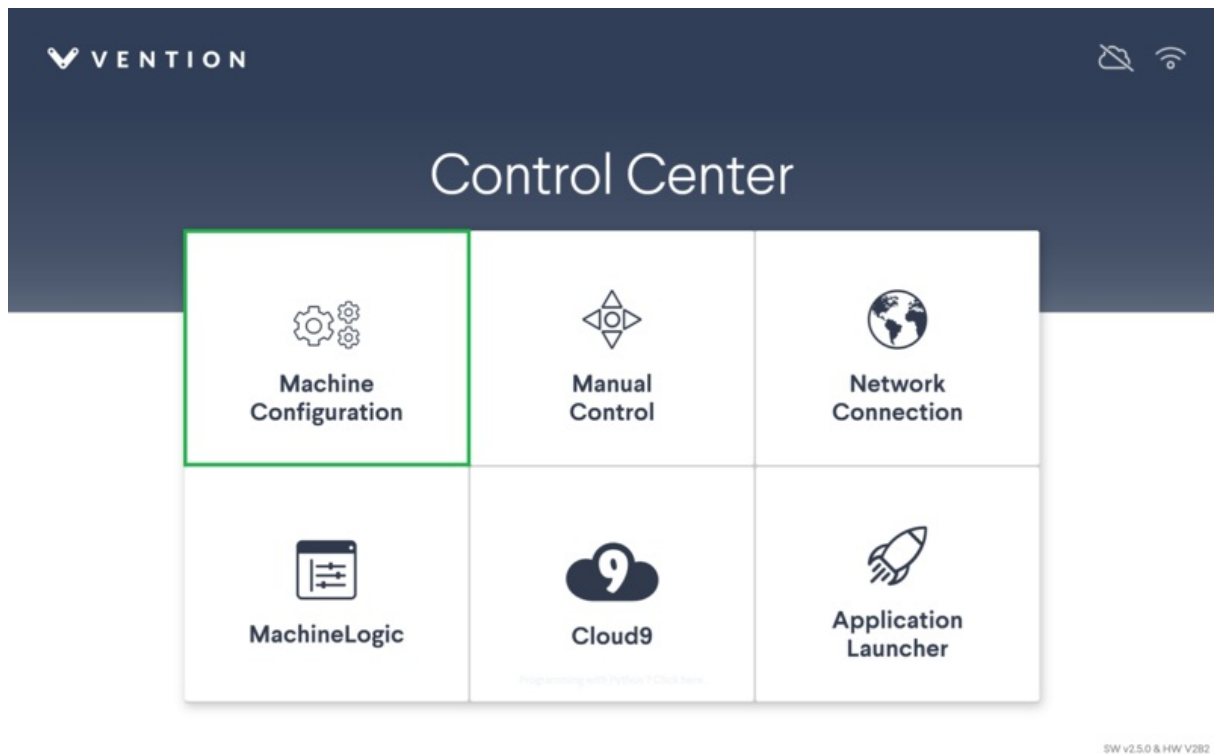

Figure 13: Control Center Main Menu

Step 2: Adding a Robot

On the Configuration page, select **Add Robot**. A Robot configuration card should appear (see Figure 14).

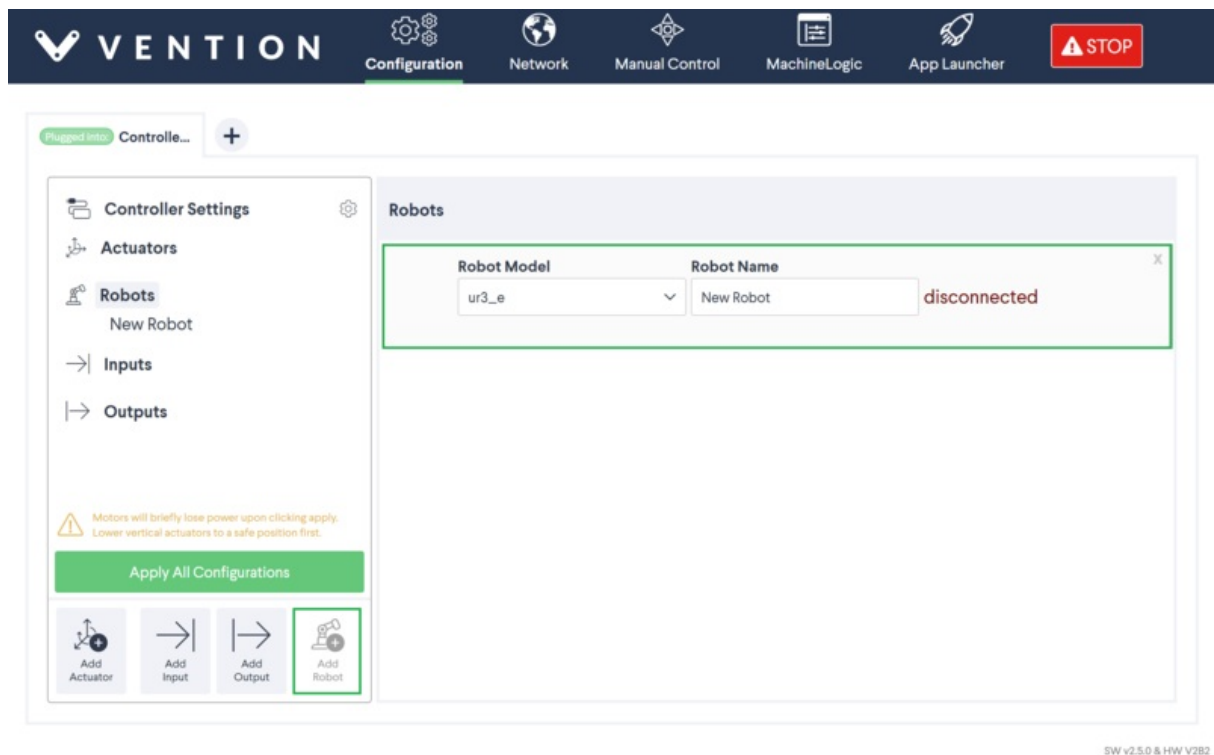

Figure 14: Add a Robot

Step 3: Applying the Configuration

Select the robot type from the **Robot Model** dropdown (see Figure 15a). The UR3e, UR5e, UR10e, and UR16e models are all currently supported. A friendly name can be given to the robot by typing in the **Robot Name** field. Once complete, select **Apply All Configurations**.

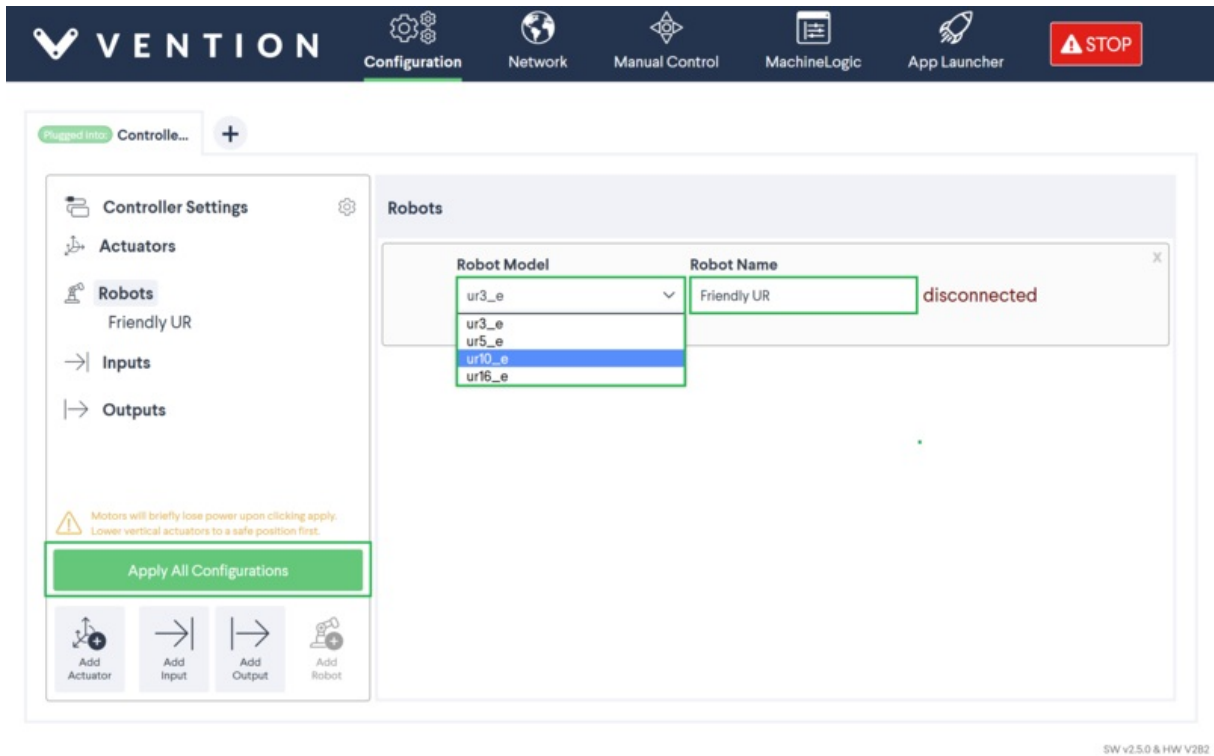

Figure 15a: Apply Configuration

The robot may take a moment to connect. If everything above was properly done above, the robot configuration card will show a successful connection status (see Figure 15b).

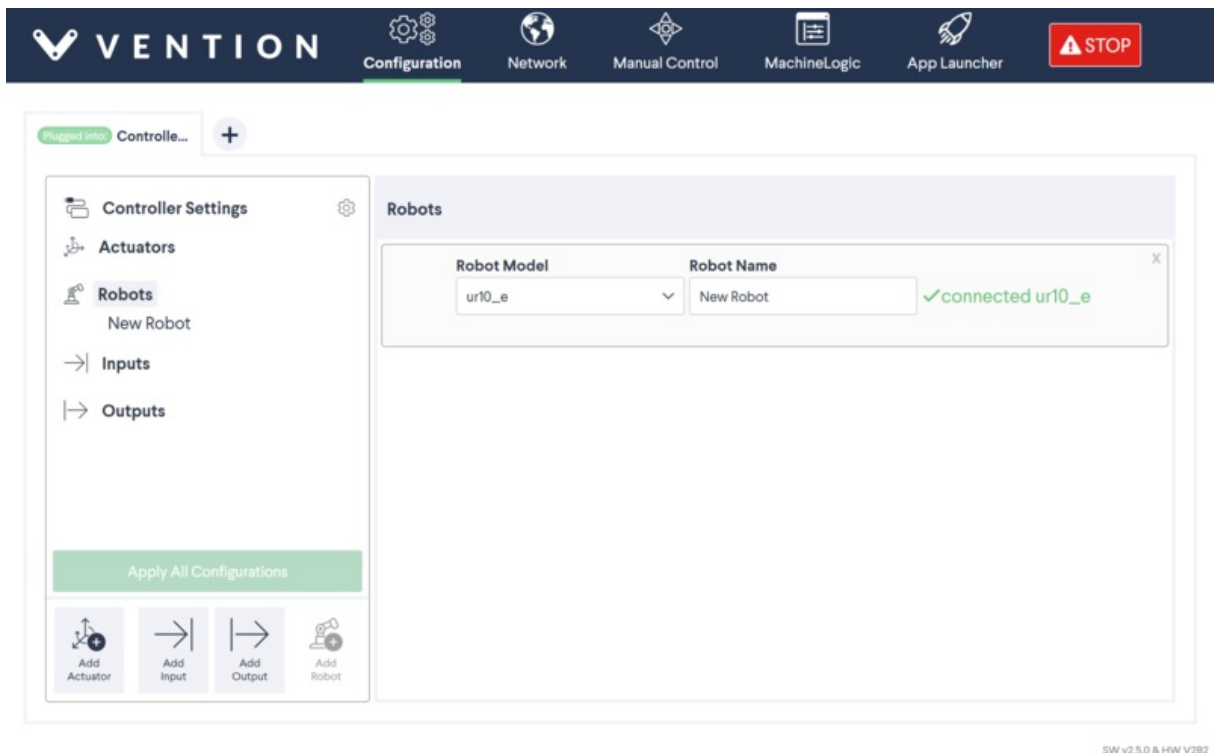

Figure 15b: Connected

You are now ready to program your Universal Robot directly in MachineLogic alongside other Vention components!

3.2 Troubleshooting

If the robot connection fails (see Figure 16), there could be a few reasons that are the root cause:

- The robot controller is still in **Local** mode, and not in **Remote Control** - See **2.5 - Step 3** to enable **Remote Control**.
- The Universal Robot Program (.urp) is **not playing** on the robot controller - Make sure everything is properly connected, as the program should play immediately.
- The **IP addresses** set in **1.2** and **2.2 - Step 2** are incorrectly set. Verify that the correct **IP address** was entered for both the network and URcap host.
- The **Robot Safety Module** is not properly wired, not allowing proper communication. Verify your system wiring per section **1.1**.

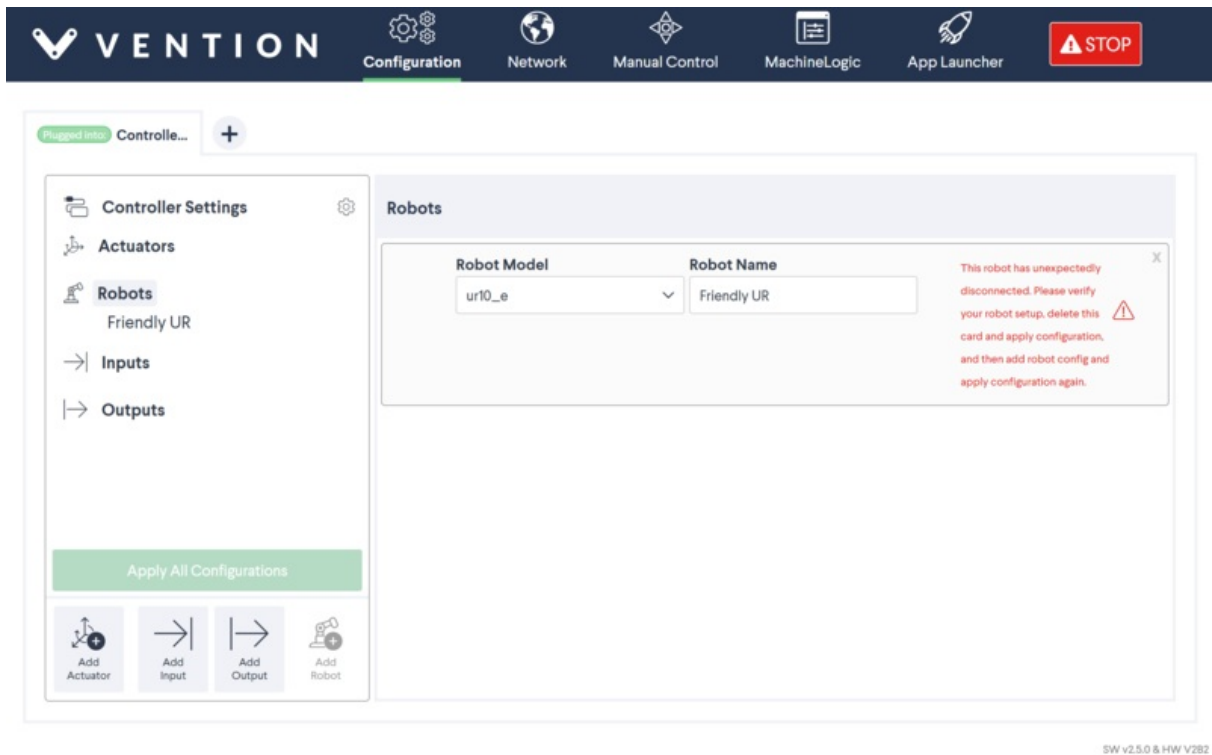

Figure 16: Disconnected

If a robot has been previously configured and connected, and any of the above occurs, simply delete the configuration card. Follow from **3.1 - Step 2** onward to re-configure the robot.